

Shower Tray Fitting Instructions

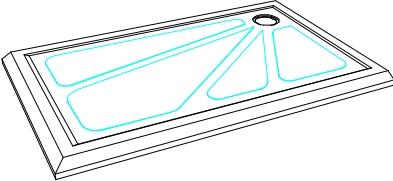

 <p>MALLARD / TEAL / WAGTAIL RIGHT HAND ILLUSTRATED</p>	 <p>PEACOCK / OWL / LAPWING NOT HANDED</p>
 <p>GADWALL RIGHT HAND ILLUSTRATED</p>	 <p>ALBATROSS NOT HANDED</p>
 <p>KESTREL NOT HANDED</p>	 <p>FALCON NOT HANDED</p>

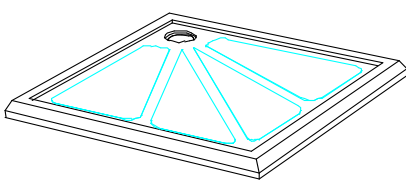
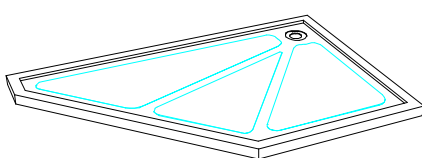
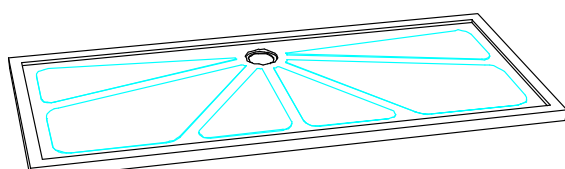
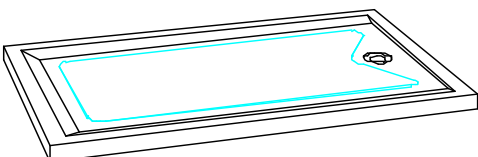
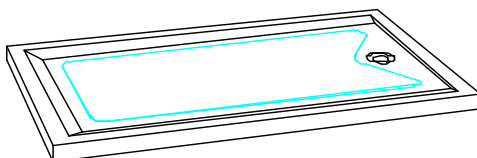
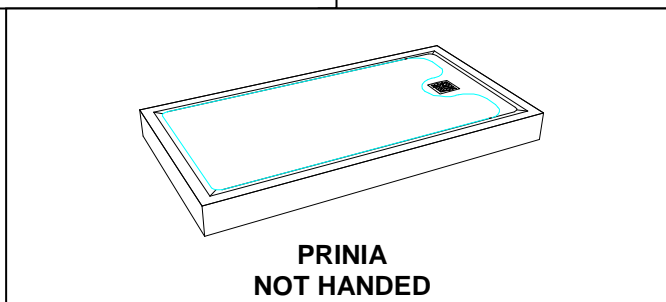

We **DO NOT** approve the use of power showers in special needs shower trays



IMPORTANT to protect the shower tray from being marked whilst being installed, please cover with a cardboard covering



For technical assistance with your installation or any other technical help please call:
0845 402 9924

IMPORTANT:

It is very important that the shower tray is level when fitted, using a spirit level check the flat area, around the edge of tray. This area should be level regardless of the floor level. You should ensure there is a good fall to the waste!

TRAY FITTING INSTRUCTIONS

WOODEN OR SOLID FLOOR INSTALLATION

1. Place the tray in the corner to which it is going to be finally positioned.
2. Decide the position of the waste pipe and cut out floor as required to suit.
3. Fit shower trap to waste pipe.
4. Before bedding tray into position apply a weak sand and cement mix on to the floor to fill any voids between the tray and the floor, **not** necessary if using a Falcon, Kestrel or Prinia tray.
5. Fit the tray into position ensuring the outlet / trap fits neatly into the shower tray.

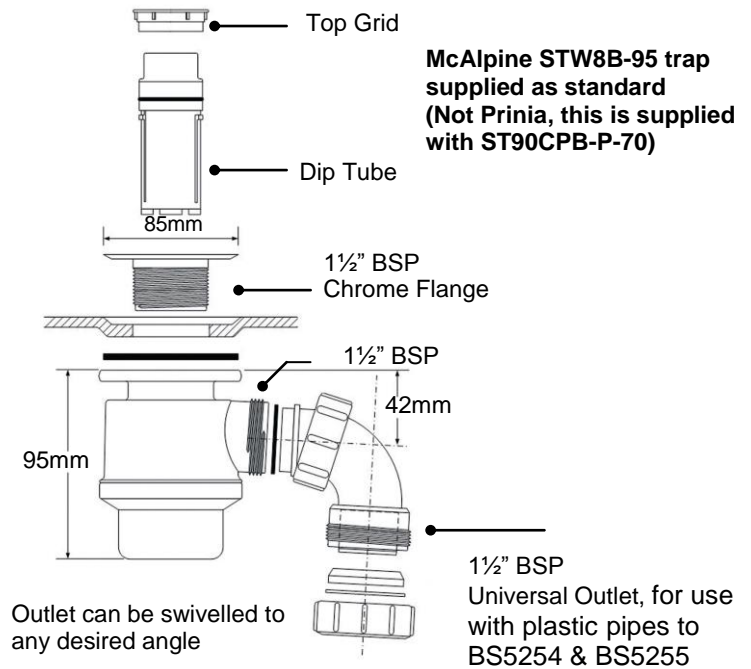

McAlpine STW8B-95 trap supplied as standard (Not Prinia, this is supplied with ST90CPB-P-70)

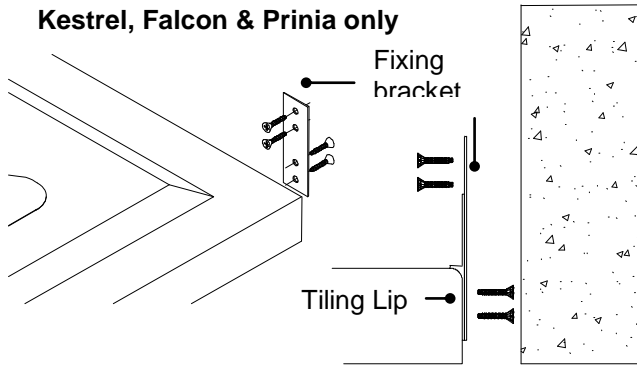

Fixing brackets are provided to fix the tray to the walls. It may be necessary to recess the bracket into the wall by removing some of the plaster

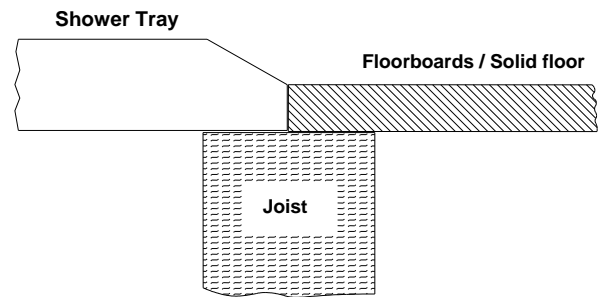
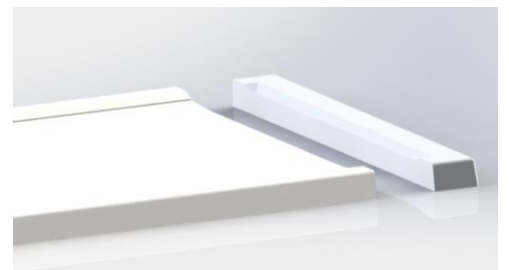

Illustration below shows either Peacock, Owl, Lapwing, Mallard, Teal, Wagtail or Gadwall recessed by 20mm into a wooden floor situation

NOTE:

A Falcon tray can be recessed into the floor by 40mm to gain level access. A Kestrel would require only 35mm of floor removal. Peacock, Owl, Lapwing, Mallard, Teal, Wagtail or Gadwall can be recessed into the floor by 20mm for lower access, see above right.

6. Falcon & Prinia 1800x700 & 1800x800 trays can be cut to size, minimum length 1500mm, to fit exactly into the space where a bath was. Use a suitable hand or circular saw to do this. Use masking tape to prevent clipping the trays edge when cutting
7. An end plate is supplied for the Falcon to conceal the cut end of the tray when installed between three walls. Use silicone sealant to form a seal between the tray and the end plate.



The Falcon has a block fitted to the under side of the tray for additional support, this can be knocked off if not required.

8. With tray finally in position, seal the tray to the walls using a silicone sealant **BEFORE** any tiles are applied to the walls.
9. Tile the walls.

YOU ARE NOW READY TO FIT YOUR SHOWER ENCLOSURE